

MESURES

DIMENSIONS H x L x P	943x1091x465 mm
POIDS BRUT/NET	160/151 kg
PORTE ENTREE BOIS	870x300 mm
SORTIE DE FUMÉES	Ø 150-153 mm Verticale
PRISE D'AIR EXTÉRIEUR	Ø 80 mm

CARACTERISTIQUES

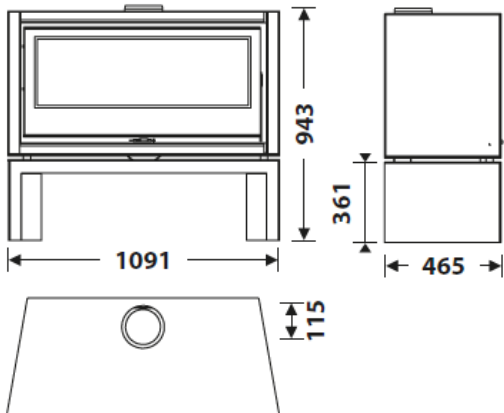







GRILLE EN FONTE	
CORPS EN ACIER DE	5+3 mm
PUISSANCE	8,9 KW
RENDEMENT	80,8 %
EMISSION DE CO	0,10 %
PEINTURE ANTICALORIFIQUE RÉSISTANCE	800°C
VERRE VITROCÉRAMIQUE RÉSISTANCE	750°C



PLUS PRODUIT

ECODESIGN

COMPATIBLE BBC
COMFORME RT 2012

-  **PRISE D'AIR EXTÉRIEUR**
-  FOYER REVÊTU EN VERMICULITE
-  PORTE EN VERRE SERIGRAPHIÉ
-  BÛCHES DE 80 CM
-  **240 m³** VOLUME DE CHAUFFE
-  DOUBLE COMBUSTION
-  SYSTÈME VITRE PROPRE
-  DOUBLE CORPS EN ACIER 5+3 MM



EAN STOVE BENCH 8426964243550
REF. STOVE BENCH 24355

EAN PANORAMIC STOVE 8426964243505
REF. PANORAMIC STOVE 24350

PANORAMIC + STOVE BENCH EcoDesign



BlmSchV2

